



AVS 1001HF/AVS 1003LF

MINIATURE INDUSTRIAL SYSTEMS
FOR VIBRATION AND TEMPERATURE
MONITORING WITH BUILT-IN SIGNAL
PROCESSING

amc VIBRO

2e, Pilotów St.
31-462 Kraków, PL

T: +48 (12) 362 97 60
S: + 48 (12) 362 97 63
info@amcvibro.com

KRS No.: 0000618618
REGON No.: 364497010
VAT No.: 6772403385

www.amcvibro.com

USER MANUAL

2026

Table of contents

1. Introduction	3
2. Applications	3
3. Calculated parameters	3
4. Dimensions	5
5. Technical data	6
6. Software update	8
7. Configuration in AVSM, reading vibration data, raw signal and data export	11
8. Connection to the PLC/SCADA controller	15

1. Introduction

AVS are either **single (1001HF)** or **triaxial (1003LF)** miniature industrial systems for vibration and temperature monitoring with built-in signal processing, all enclosed in a sensor-sized housing.

AVS modules allow for the reading of parameter values such as **Peak-to-Peak, RMS acceleration, RMS velocity**, as well as **temperature** directly from the module using any device that supports the **Modbus RS-485** communication protocol.



2. Applications

The modules detect, among others:

- » **[Shafts]** unbalance, misalignment, looseness (loose connections), coupling damage.
- » **[Drives]** rotor unbalance, mechanical looseness, mounting issues.
- » **[Fans]** blade unbalance, uneven blade loading, shaft misalignment or looseness.
- » **[Gearboxes]** tooth wear or damage, raceway wear, backlash..

3. Calculated parameters

The modules continuously measure the vibration acceleration signal. The most important diagnostic parameters are determined from the signal:

AVS 1001HF

PARAMETER	DESIGNATION	DESCRIPTION
peak acceleration value	acc Peak	early detection of failures
RMS acceleration value	acc RMS	general level of technical condition
RMS velocity value	vel RMS	general level of technical condition
peak envelope value	env Peak	early detection of failures, especially of rolling bearings and gears
RMS envelope value	env RMS	early detection of failures, especially of rolling bearings and gears
temperature	Temp	complement information about the dynamic state

AVS 1003LF

PARAMETER	DESIGNATION	DESCRIPTION
peak acceleration value	X accPeak, Y accPeak, Z accPeak	early detection of failures
RMS acceleration value	X accRMS, Y accRMS, Z accRMS	general level of technical condition
RMS velocity value	X velRMS, Y velRMS, Z velRMS	general level of technical condition
temperature	Temp	complement information about the dynamic state

The parameters can be read via the RS-485 connector in the popular industrial MODBUS protocol (slave RTU, 115 kbps).

The modules can also read the original **raw vibration signal**. A dedicated communication protocol is used for this purpose. Raw data is read at a speed of 1.5 Mbps, which allows data acquisition in real time.

4. Dimensions

ELECTRICAL CONNECTOR
M12 [0,47] - 5 PIN

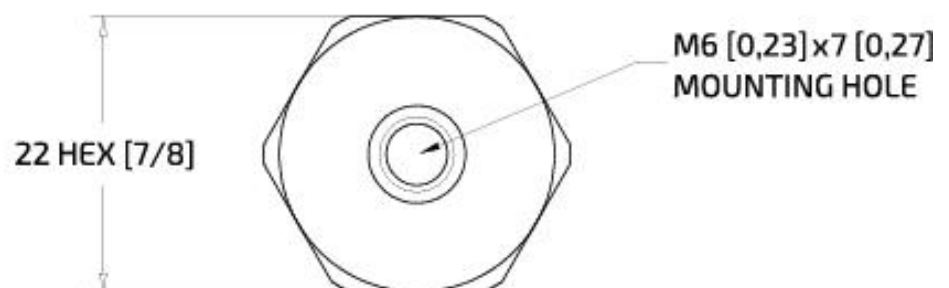
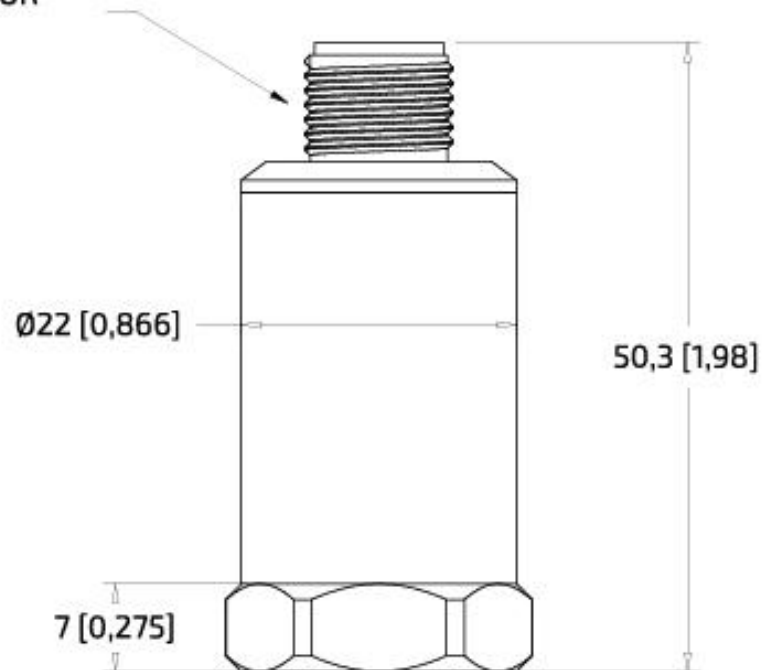

5. Technical data

	AVS 1001HF	AVS 1003LF
MEASUREMENT RANGE		
Number of measurement axes	1: Z	3: Z,Y,X
Measurement range [g]	± 50, peak	± 40
Frequency range [Hz]	1 Hz do 11 kHz	1 Hz do 1 kHz
ELECTRICAL DATA		
Operating voltage [V]	24 V DC	
Current consumption [mA]	13	
Reverse polarity protection	Yes	
Type of sensor	Microelectromechanical system (MEMS)	
OUTPUTS		
Interface	RS485 115 kbps (calculated parameters) RS485 1.5 Mbps (raw signal)	
Calculated parameters	acc Peak, acc RMS, vel RMS (ISO), env Peak, env RMS, Temp	X accPeak, Y accPeak, Z accPeak, X accRMS, Y accRMS, Z accRMS, X vel RMS (ISO), Y vel RMS (ISO), Z vel RMS (ISO), Temp
Raw vibration signal	Yes	
Maximum number of connected units	100 - ADI protocol	
ACCURACY		
Linearity deviation	± 0,1%	± 0,1 % FSR
Temperature dependence	± 5% (-40 °C ... +85 °C)	
Transverse sensitivity	± 1%	1,5%
Sensitivity	40 mV/g	100 mV/g
Noise density	25 µg / √Hz	80 µg / √Hz

OPERATING CONDITIONS	
Ambient temperature [°C]	-40 °C ... +85 °C
Protection class	IP67
TESTS / APPROVALS	
EMC	EN IEC 61326-1:2021
Shock resistance	DIN EN 60068-2-27 100 g 11 ms
Vibration resistance	DIN EN 60068-2-6 20 g / 10 ... 3000 Hz
Maximum shock resistance [g]	10 000, peak 5 000, peak
Electrical isolation (case)	1 MΩ
RoHS	Yes
CE	Yes
MECHANICAL DATA	
Dimensions [mm]	Φ 22 x 50,3
Weight [g]	72
Type of mounting	M6 x 7 threaded hole in sensor
Material	Housing: stainless steel
Tightening torque [Nm]	7
Connector (or integrated cable)	5 pin M12 (shielded 2 x 2 x 0.14 mm ²)
ACCESSORIES	
Components	Set screw: M6 to M6
ELECTRICAL CONNECTION - PLUG	
	<ul style="list-style-type: none"> » AVS 1003LF - Top exit connector: M12 5-pin; maximum cable length: 300 m » AVS 1003LFC - DATAPUR-C 2x2x0,14 QMM; default cable length: 5 m

6. Software update

1. Connect the sensor to the computer using the AVS LINK adapter.
AVS LINK should only be connected to USB-A ports, as it is not compatible with USB-C ports.



Computer -> USB/USB C cable -> AVS Link adapter -> AVS Module

2. Next, launch the AV SENSOR MANAGER program, find the appropriate communication port on the left side, and click on it with the left mouse button. In the example, it is COM8.

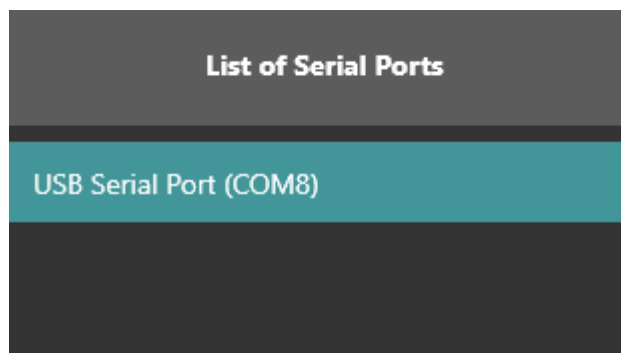

View from point 2

- Refresh the list of devices by clicking the button on the left side of the "List of Devices" tab, then select the appropriate module.

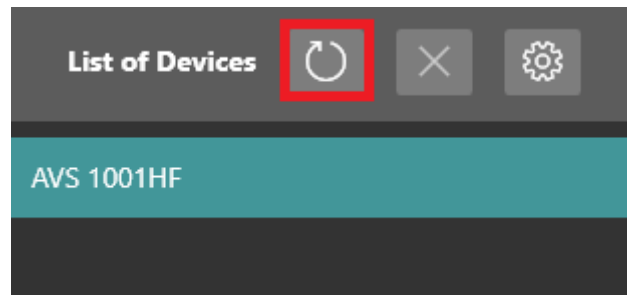

View from point 3

- Load the appropriate configuration using the "Load software" button. It is a .amcSft file. Depending on the module type (HF or LF), you need to select the corresponding configuration.

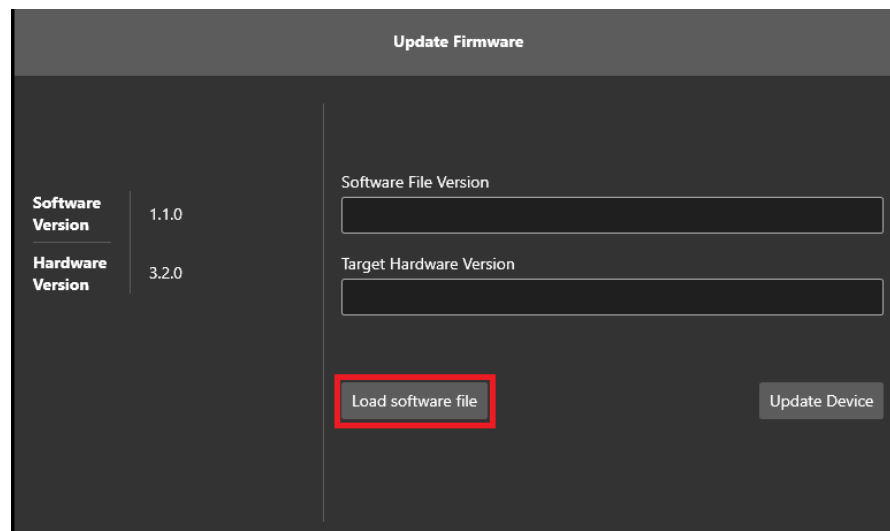

View from point 4

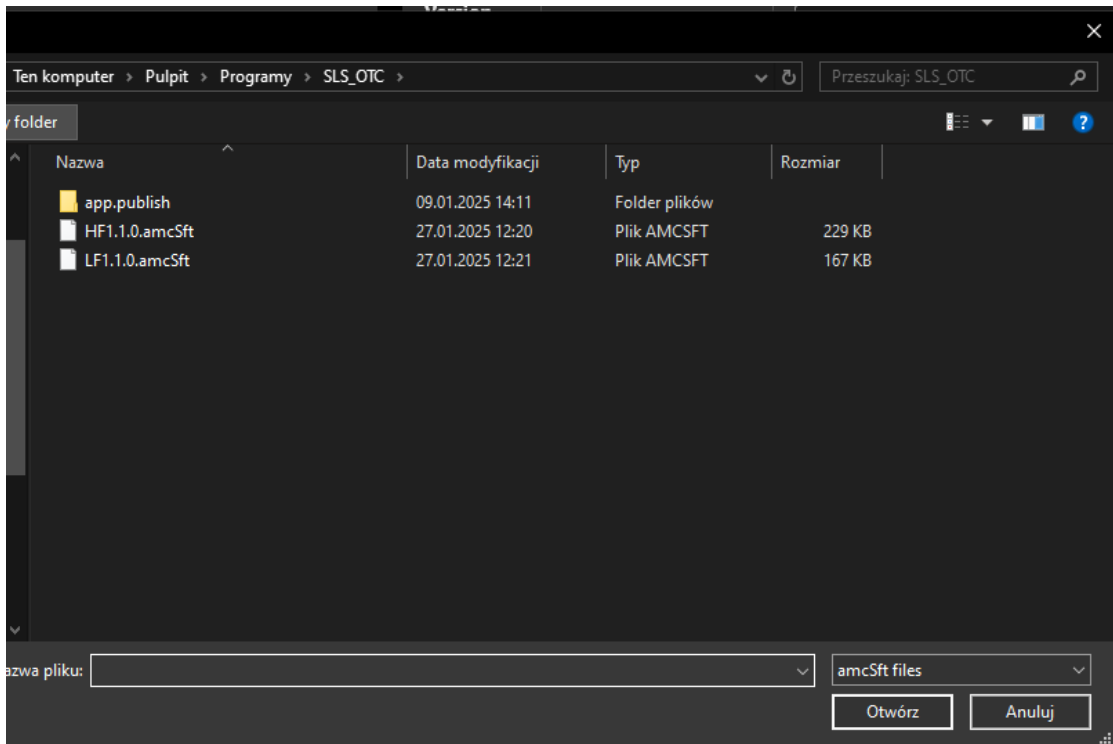

View of the loaded version

5. After loading the appropriate configuration, click the "Update Device" button.

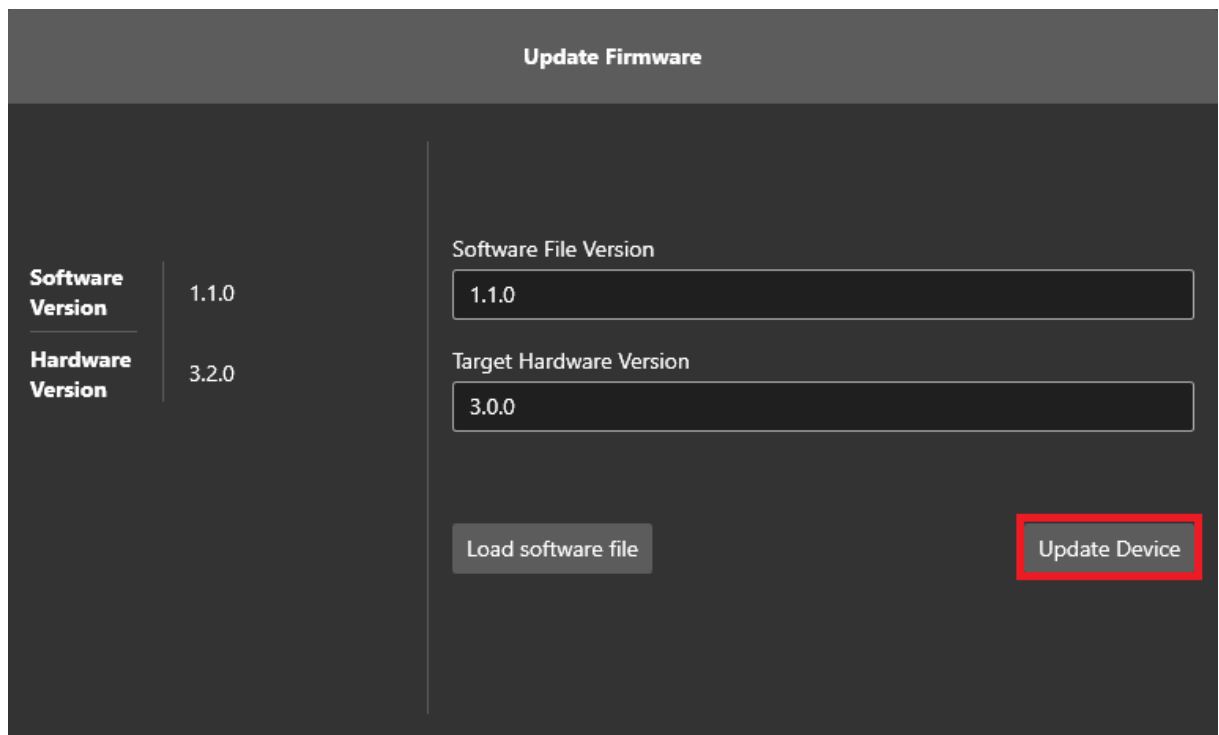

View from point 5

7. Configuration in AVSM, reading vibration data, raw signal and data export

1. Connect the module to your computer using the AVS LINK adapter.



Computer -> USB/USB C cable -> AVS Link adapter -> AVS Modules

2. Launch AV SENSOR MANAGER.
3. Locate the appropriate communication port on the left and left-click it. In this example, it's COM6.

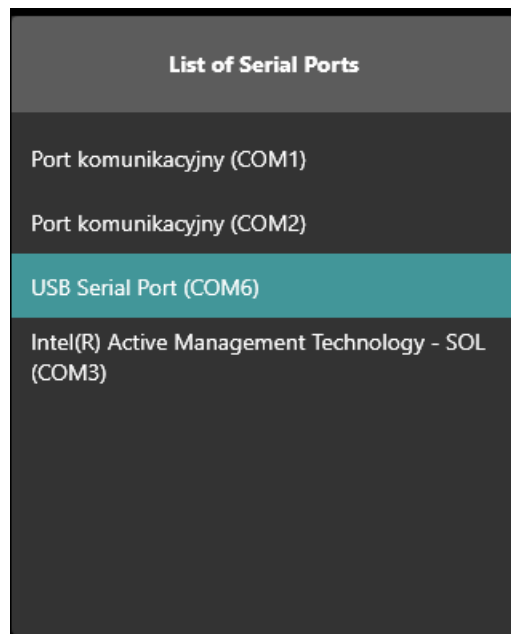

View from point 3

- Then refresh the device list by clicking the button on the left side of the "List of Devices" tab and select the appropriate module.

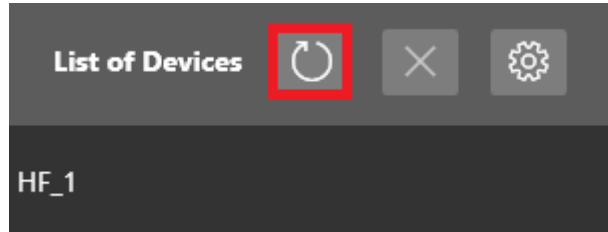

View from point 4

- At the top, select the communication protocol. After changing it, confirm it by clicking "Change Protocol Now". In the "New Device Name" tab, enter the appropriate device name, and in the "New ID" tab, enter the appropriate ID by which the device will be searched. Below this are the "Baud Rates" for the specific protocol type. The AV SENSOR PROTOCOL defaults to 1,500,000 [Bd]. Modbus 9600 [Bd].

Default Communication Protocol

Modbus RTU ▼

Change Protocol Now

Device Type	AVS 1001HF
Device Name	HF_1
UID	47:00:23:00:0D:51:32:30:34:34:35:30 📄
ID/Modbus ID	1

New Device Name

HF_1

New ID

1 ⬆️ ⬇️

AV Sensor Protocol Baud Rate

1 500 000 [Bd] ▼

Modbus RTU Baud Rate

9600 [Bd] ▼

Update Device

View from point 5

- Then in the "Measurements" "Modbus RTU" tab you can check the module readings by selecting "Reading data from device".

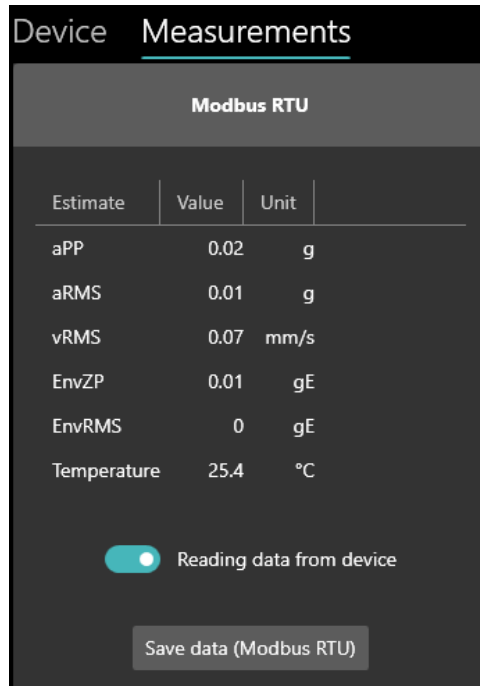

View from point 6

- To save data, select "Save data (Modbus RTU)".

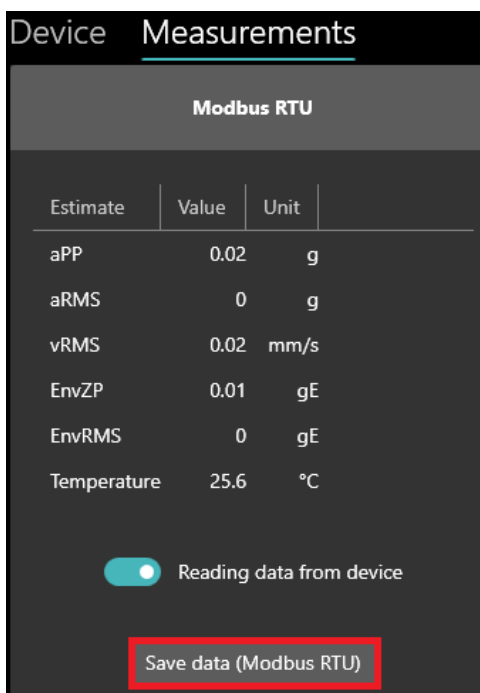

View from point 7

- To read the raw signal, uncheck "Reading data from device" from point 6, and then in the "Measurements" "AV SENSOR PROTOCOL" tab, select "Start reading".

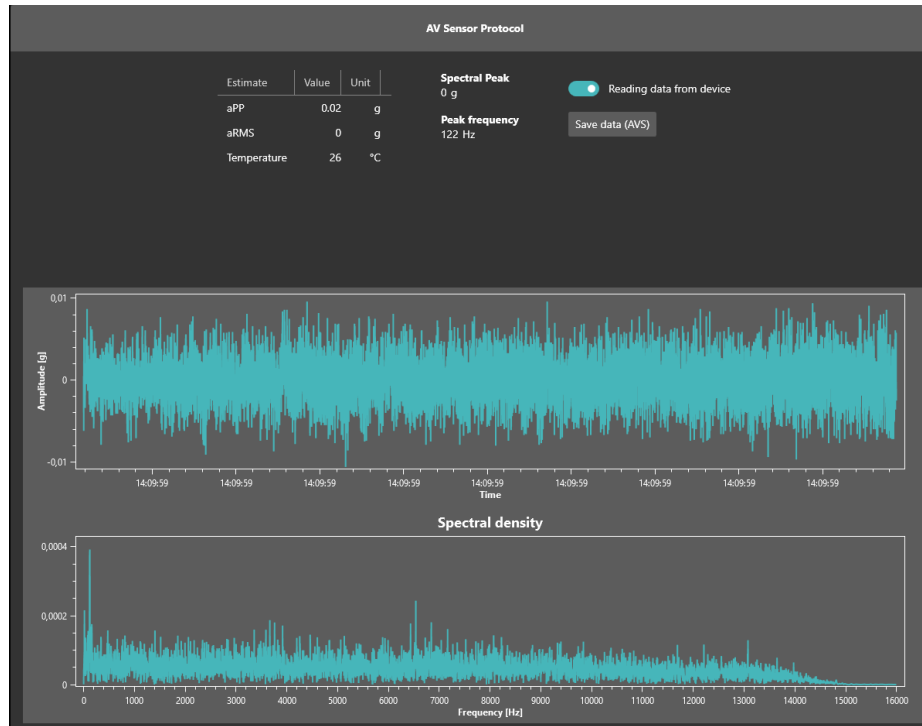

View from point 8

- To save data, select "Save data (AVS)".

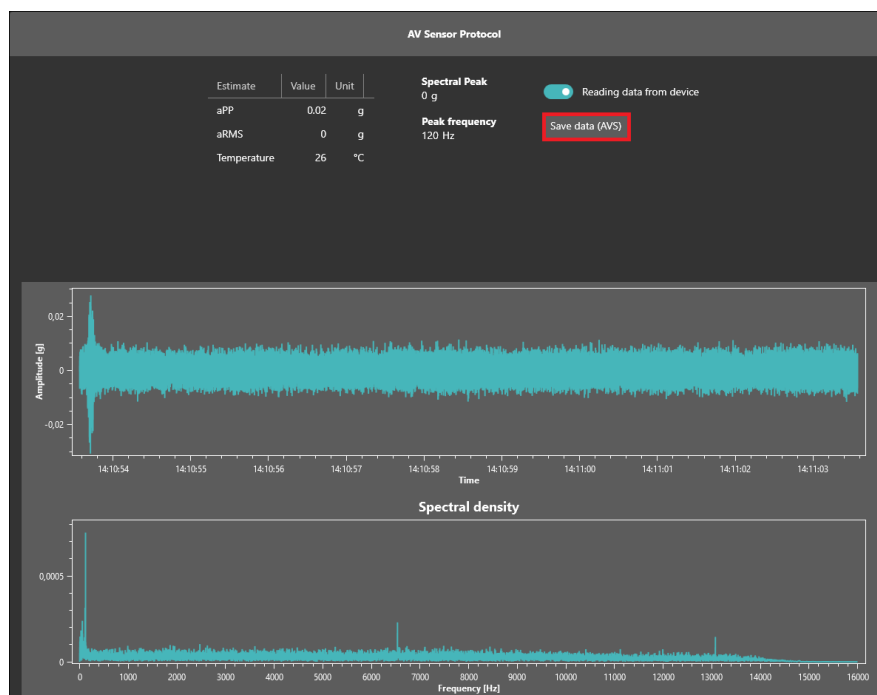

View from point 9

8. Connection to the PLC/SCADA controller

In this configuration, a PLC or industrial computer with an RS-485 interface and MODBUS protocol can be used for reading. Data is read at 115 kbps. A single RS-485 port can be used to connect multiple AVS modules to a bus, significantly reducing cabling costs.

Modules can be connected in series (termination must be used) or in parallel.

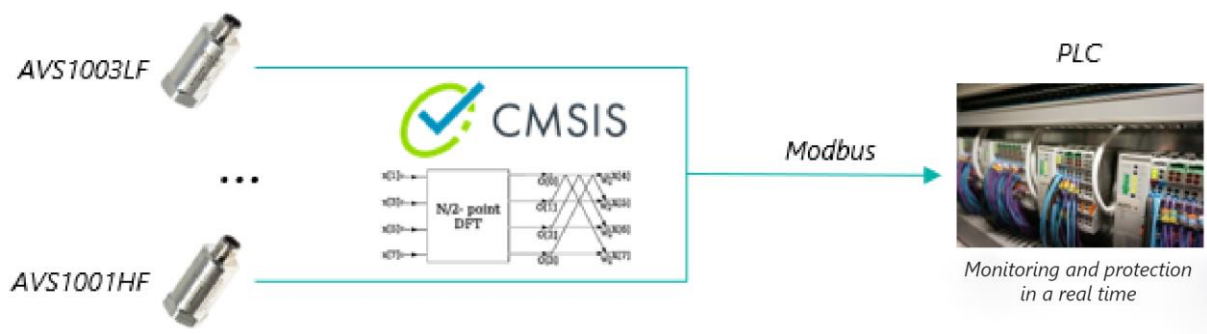

Below are the Modbus register maps that should be used to read the data issued by the module.

Register numbers for the AVS 1003LF module:

Name	Unit	Typ	Accuracy	Function	Address (dec)	Offset (hex)	Offset (dec)	Length (hex)	Length (dec)
Sensor ID	[char]	uint16	-	Read	1	0x00	0	0x01	2
MAC	[char]	uint8 [12]	-	Read	2-7	0x02	2	0x0C	12
Speed	-	uint8	-	Read/Write	8	0x0E	14	0x02	2
Name	[char]	char [12]	-	Read/Write	9-14	0x10	16	0x0C	12
X Calibration A	-	float 32	As float	Read/Write	15-16	0x1C	28	0x04	4
X Calibration B	-	float 32	As float	Read/Write	17-18	0x20	32	0x04	4
X Calibration Sensitivity	-	float 32	As float	Read/Write	19-20	0x24	36	0x04	4
Y Calibration A	-	float 32	As float	Read/Write	21-22	0x28	40	0x04	4
Y Calibration B	-	float 32	As float	Read/Write	22-24	0x2C	44	0x04	4
Y Calibration Sensitivity	-	float 32	As float	Read/Write	25-26	0x30	48	0x04	4
Z Calibration A	-	float 32	As float	Read/Write	27-28	0x34	52	0x04	4
Z Calibration B	-	float 32	As float	Read/Write	29-30	0x38	56	0x04	4
Z Calibration Sensitivity	-	float 32	As float	Read/Write	31-32	0x3C	60	0x04	4
Temperature	°C	float 32	10 ⁻¹	Read	33-34	0x40	64	0x04	4
X Acceleration Peak-to-Peak	g	float 32	10 ⁻³	Read	35-36	0x44	68	0x04	4
X Acceleration Root Mean Square	g RMS	float 32	10 ⁻³	Read	37-38	0x48	72	0x04	4
X Velocity Root Mean Square	mm/s RMS	float 32	10 ⁻³	Read	39-40	0x4C	76	0x04	4
Y Acceleration Peak-to-Peak	g	float 32	10 ⁻³	Read	41-42	0x50	80	0x04	4
Y Acceleration Root Mean Square	g RMS	float 32	10 ⁻³	Read	43-44	0x54	84	0x04	4
Y Velocity Root Mean Square	mm/s RMS	float 32	10 ⁻³	Read	45-46	0x58	88	0x04	4
Z Acceleration Peak-to-Peak	g	float 32	10 ⁻³	Read	47-48	0x5C	92	0x04	4

Z Acceleration Root Mean Square	g RMS	float 32	10 ⁻³	Read	49-50	0x60	96	0x04	4
Z Velocity Root Mean Square	mm/s RMS	float 32	10 ⁻³	Read	51-52	0x64	100	0x04	4
Is HF (1)	bool	uint16	-	Read	53	0x68	104	0x02	2
Software version major, minor, patch	[char]	uint16 [3]	-	Read	54	0x6A	106	0x06	6
Hardware version major, minor, patch	[char]	uint16 [3]	-	Read	57	0x70	112	0x06	6

Register numbers for the AVS 1001HF module:

Name	Unit	Typ	Accuracy	Function	Address (dec)	Offset (hex)	Offset (dec)	Length (hex)	Length (dec)
Sensor ID	[char]	uint16	-	Read	1	0x00	0	0x01	2
MAC	[char]	uint8 [12]	-	Read	2-7	0x02	2	0x0C	12
Speed	-	uint8	-	Read/Write	8	0x0E	14	0x02	2
Name	[char]	Char [12]	-	Read/Write	9-14	0x10	16	0x0C	12
X Calibration A	-	float 32	As float	Read/Write	15-16	0x1C	28	0x04	4
X Calibration B	-	float 32	As float	Read/Write	17-18	0x20	32	0x04	4
X Calibration Sensitivity	-	float 32	As float	Read/Write	19-20	0x24	36	0x04	4
Unused	-	-	-	Not used	21-32	0x28	40	0x18	24
Temperature	°C	float 32	10 ⁻¹	Read	33-34	0x40	64	0x04	4
Peak-to-Peak	g	float 32	10 ⁻³	Read	35-36	0x44	68	0x04	4
Acceleration Root Mean Square	g RMS	float 32	10 ⁻³	Read	37-38	0x48	72	0x04	4
Velocity Root Mean Square	mm/s RMS		10 ⁻³	Read	39-40	0x4C	76	0x04	4
Envelope Zero Peak	g	float 32	10 ⁻³	Read	41-42	0x50	80	0x04	4
Envelope Root Mean Square	mm/s Rms	float 32	10 ⁻³	Read	43-44	0x54	84	0x04	4
Unused	-	-	-	Not used	45-52	0x58	88	0x10	16
Is HF (1)	Bool	uint16	-	Read	53	0x68	104	0x02	2

Software version major, minor, patch	[char]	uint16 [3]	-	Read	54	0x6A	106	0x06	6
Hardware version, patch	[char]	uint16 [3]	-	Read	57	0x70	112	0x06	6

Modbus speed:

Lp	Value (dec)	Value (hex)	Speed (baud)
1	16	0x10	4800
2	32	0x20	7200
3	48	0x30	9600
4	64	0x40	14400
5	80	0x50	19200
6	96	0x60	28800
7	112	0x70	33600
8	128	0x80	38400
9	144	0x90	57600
10	160	0xA0	115200