



Instruction Manual

	Page
1. Introduction	1
2. Precautions	1
3. Equipment details	1
4. Preparation for use	2
5. Buttons	3
6. Display	3
7. Connections	4
8. Battery status	4
9. Charging the unit	4
10. Connecting sensor	5
11. Measurement modes	6
12. Calculation modes	6
13. Memory recall mode	7
14. Settings menu	8
15. Setting the clock	8
16. Setting units	8
17. Setting low pass filter	9
18. Setting ISO10816 group	9
19. Clearing memories	9
20. ISO10816	10
21. Physical	11
22. Specifications	12
23. Troubleshooting	14
24. After sales support	14
A. Main operations	15
B. Conversions and formulae	16

1. Introduction

The MTN/VM220 Vibration Meter is a rechargeable, portable instrument designed to operate with a constant current type accelerometer to provide accurate vibration measurements.

Conforming to ISO10816-3/7, MTN/VM220 will display RMS, peak, peak-peak, crest factor and bearing condition on its pin-sharp colour screen. Up to 100 time-stamped readings can be stored to non-volatile memory.

The MTN/VM220 is an invaluable trouble-shooting tool for instrumentation engineers familiar with the problems of plant vibration monitoring, providing an instant readout of the condition of bearings and rotating parts.

2. Precautions

- Only use the unit as directed in this manual.
- Protect the unit from shocks and extremes of temperature, humidity and harsh environments (such as high salt).
- Use only a soft clean cloth. Do not use solvents or harsh cleaning agents.
- The unit contains no user serviceable parts. Do not attempt to disassemble or repair the unit, as this will invalidate your warranty.
- To ensure continued performance, have the unit checked and serviced at regular intervals.

3. Equipment Details

Purchase date:	
Vibration meter serial number:	
Cable serial number:	
Sensor serial number:	
Software version:	





4. Preparation for use

Carefully remove the instrument from the transit packaging and ensure all accessories supplied agree with the delivery note.

Visually inspect for transit damage.

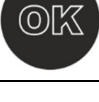

5. Buttons

	<ul style="list-style-type: none"> • Power on • Power off
	<ul style="list-style-type: none"> • Previous operating mode • Value increase
	<ul style="list-style-type: none"> • Next operating mode • Value decrease
	<ul style="list-style-type: none"> • Previous calculation mode • Previous memory slot
	<ul style="list-style-type: none"> • Next calculation mode • Next memory slot
	<ul style="list-style-type: none"> • Store value to memory slot • Select parameter



6. Display

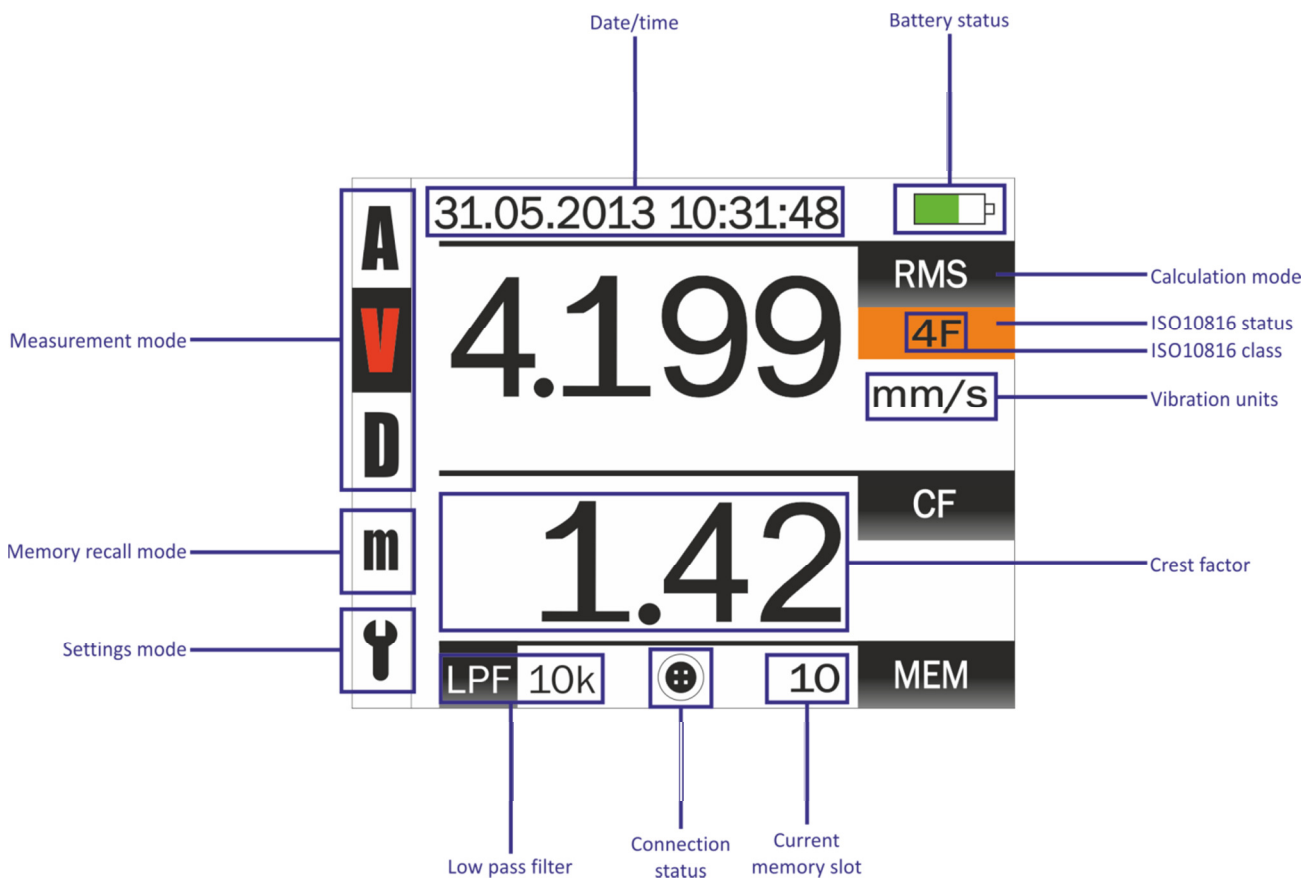

7. Connections

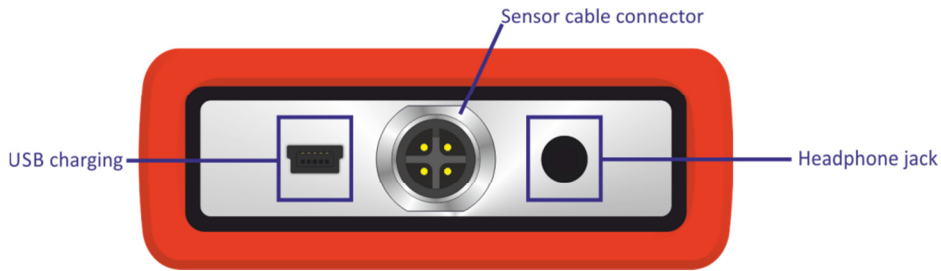

The headphone jack will accept a 3.5mm stereo jack plug. Headphones (not included) may be used to listen to the vibration directly.

To avoid hearing damage, use of headphones with an inline volume adjustment is recommended. Ensure the volume is turned down before connecting your headphones. After placing headphones in your ears, gradually turn up the volume until you reach a comfortable listening level. Do not use headphones when it's unsafe to do so - while operating a vehicle, or during any activity or in an environment where your full attention to your surroundings is required.

8. Battery status

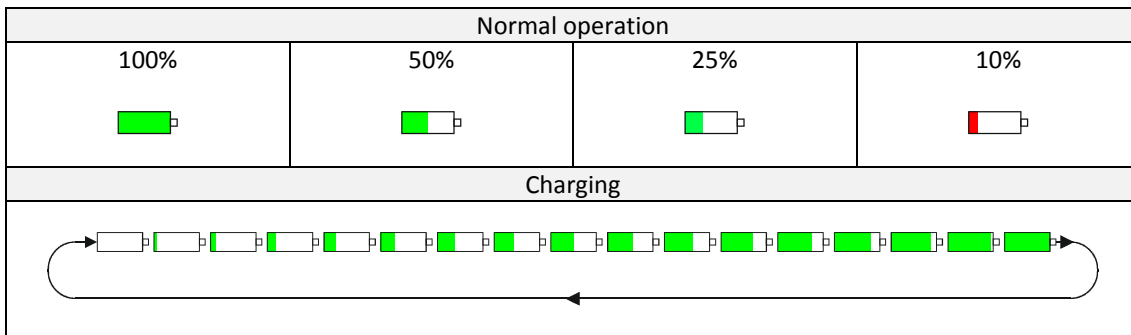

The meter will automatically turn-off after 15 minutes of inactivity (5 minutes if sensor not connected).

9. Charging the unit

The supplied multi-voltage charger comes with 4 adaptors and is suitable for use worldwide. Connect the correct adaptor for your region, plug into mains and connect the mini USB to the MTN/VM220.

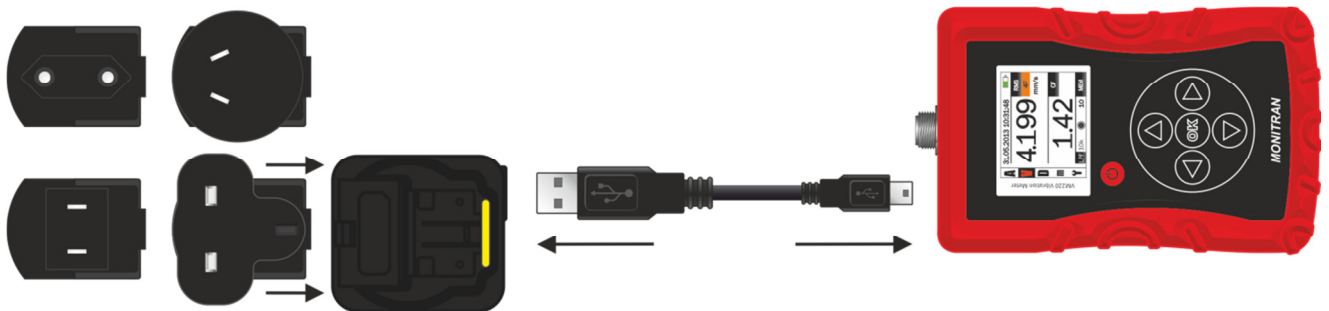

The unit should reach full charge within 4 hours. The battery status icon will indicate charging is in progress (see 6. Display & 8. Battery status).

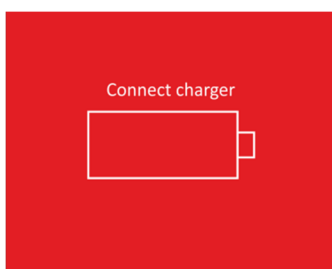

When the battery level is low, a warning screen (see left) will display for 5 seconds and the unit will power off.

10. Connecting sensor

- The sensor and cable can be connected/disconnected at any time.
- Once fully charged, briefly press the power button  to switch the unit on.

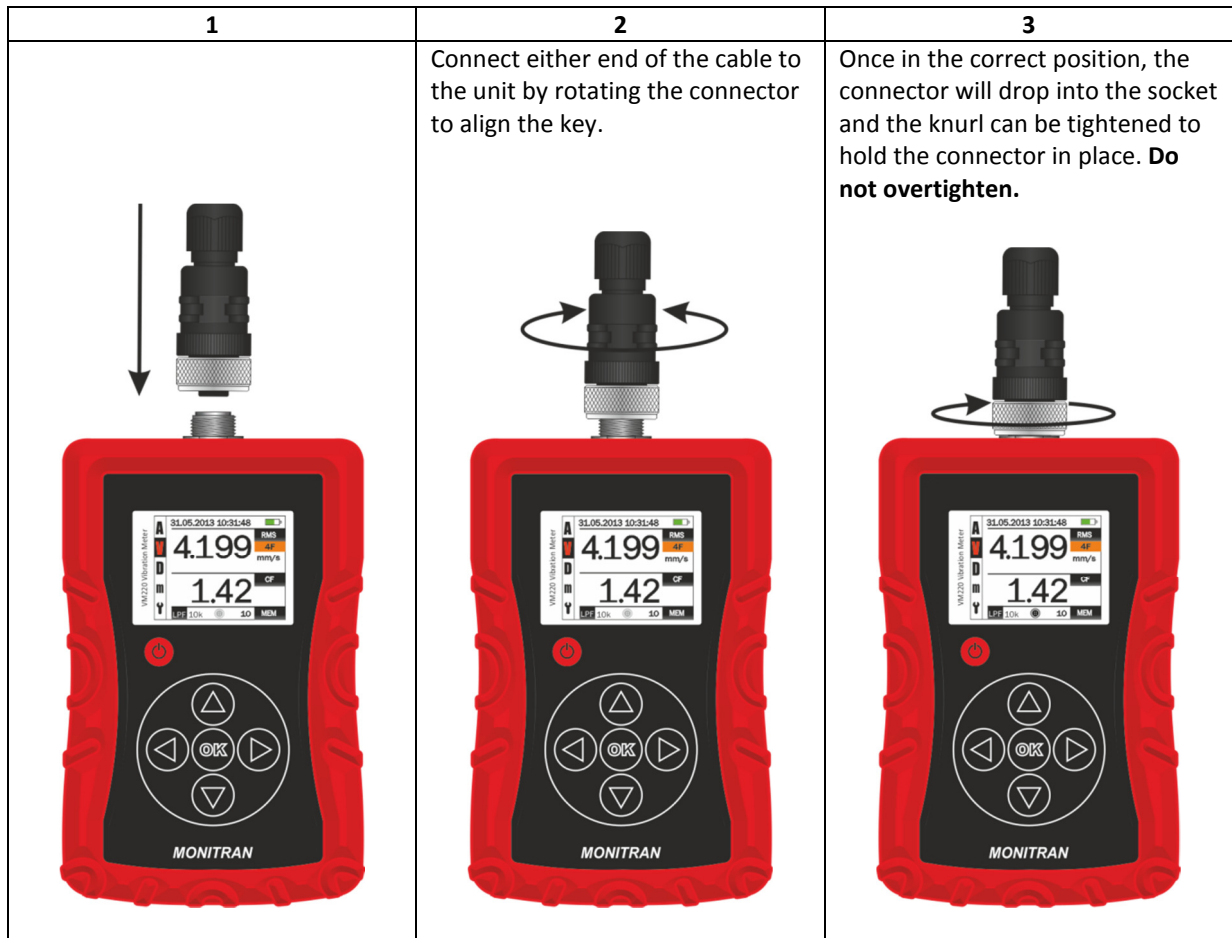

- Repeat this process to connect the sensor to the other end of the cable.

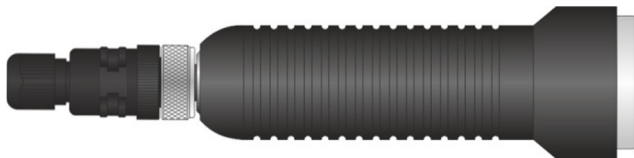

Notes:

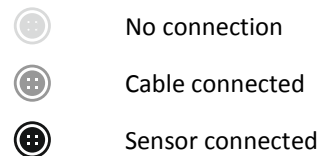

The connection status icon (see 6. Display) will change accordingly.



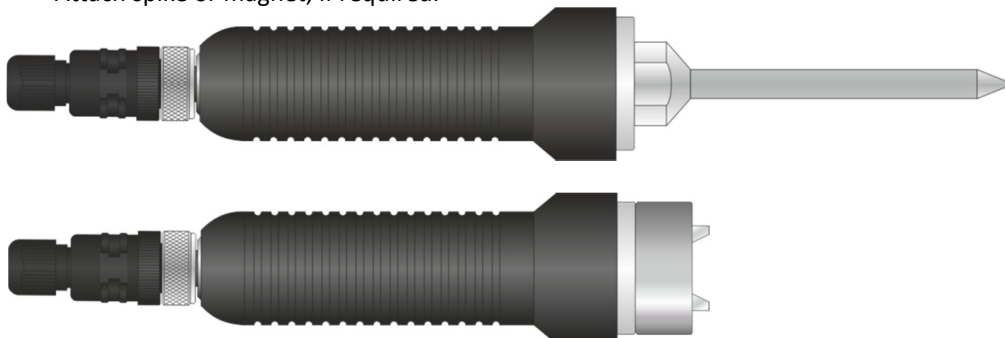

- Attach spike or magnet, if required.





11. Measurement modes

Press buttons   to switch between measurement modes.
The current mode will be highlighted.

Units for each measurement mode can be set (see 16. *Setting units*)

	MODE	UNITS	
A	Acceleration mode	g	m/s ²
V	Velocity mode	mm/s	in/s
D	Displacement mode	μm	mils
	Memory recall mode (see 13. <i>Memory recall mode</i>)		
	Settings (see 14. <i>Settings menu</i>)		

12. Calculation modes

When the unit is in one of the measurement modes (acceleration, velocity, displacement), press buttons   to switch between RMS, peak-peak and 0-peak displays. An additional bearing display is available in both acceleration and velocity measurement modes.

Display	Calculation mode
RMS	Root mean square
PK-PK	Peak to peak
0-PK	Zero to peak
B	Bearing

Press  to store the displayed value in the current memory slot. The current memory number will automatically move to the next slot.

- Current time
- Current date
- Measurement mode
- Calculation mode
- Crest factor value
- Vibration value & units

$$X_{rms} = \sqrt{\frac{(X_1^2 + X_2^2 + \dots + X_n^2)}{n}}$$

where: X_{rms} = RMS value
 X = sample
 n = number of samples

$$\text{Crest Factor} = \frac{X_{pk-pk}}{X_{rms}}$$

The Crest Factor is equal to the peak amplitude of a waveform divided by the RMS value. The purpose of the crest factor calculation is to give an analyst a quick idea of how much impacting is occurring in a waveform. Impacting is often associated with roller bearing wear, cavitation and gear tooth wear.

13. Memory recall mode

Using buttons \triangle ∇ , select memory recall mode. Press buttons \triangleleft \triangleright to navigate through memory slots.

When returning to the measurement mode, the selected memory slot will be the current memory slot for the next store.

It is possible to quickly clear all memory slots (see 18. *Clearing memories*).

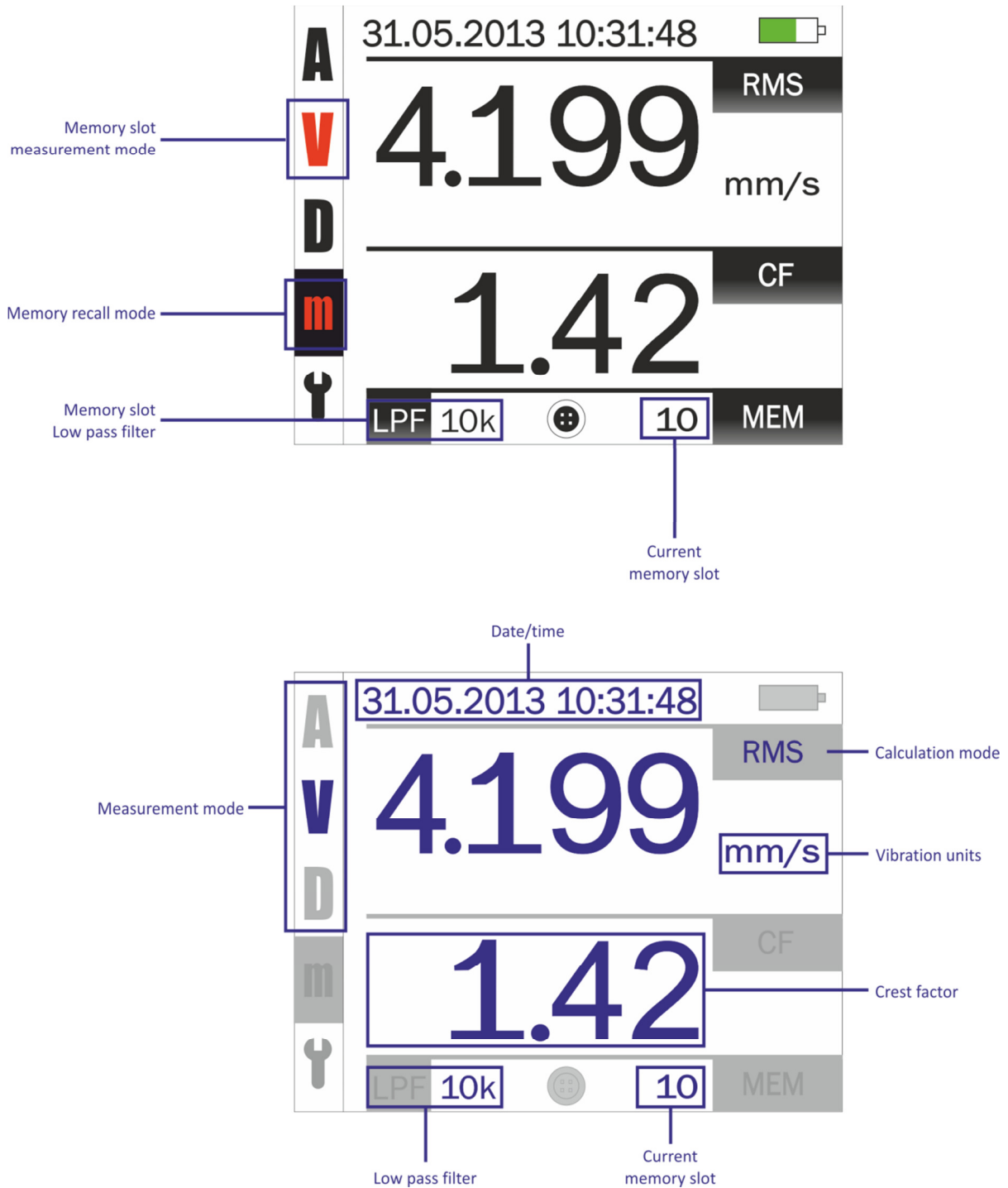

There are 100 memory slots in total. The blue fields shown in the above figure are saved into memory

Provided the unit is returned to Monitran for service, the memories will remain intact, even after battery replacement and calibration (see 24. *After Sales Support*)

14. Settings menu

- Using buttons \triangle ∇ , select Υ .
- Press button \blacktriangleright to enter settings menu.
- Use buttons \triangle ∇ \blacktriangleleft \blacktriangleright to navigate and press OK to select option.

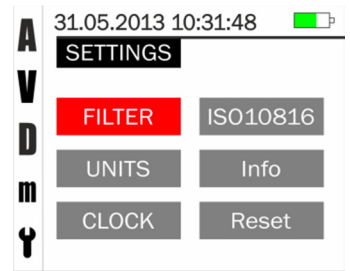

- Use button \blacktriangleleft to navigate back to the main menu.

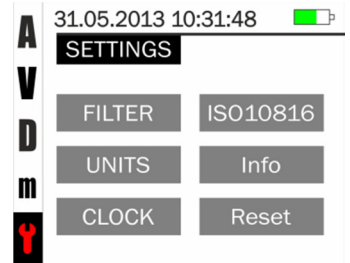

15. Setting the clock

- Enter settings menu (see 14. Settings menu)
- Press button ∇ twice to highlight CLOCK and press OK to enter clock mode.
- Use buttons \triangle ∇ to set DAY/MONTH/YEAR/HOUR/MINUTE settings.
- Press buttons \blacktriangleleft \blacktriangleright to change between DAY/MONTH/YEAR/HOUR/MINUTE.
- Press OK at any time to save and return to settings menu.

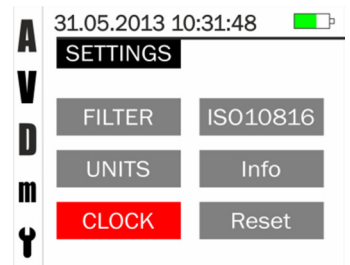



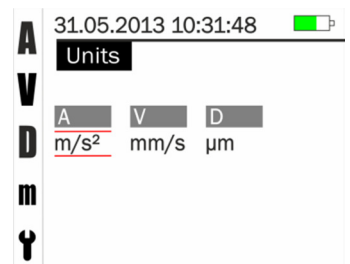
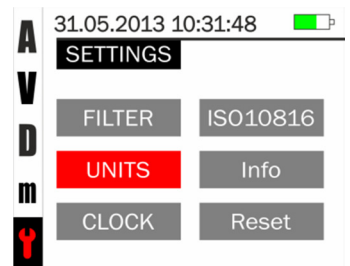

16. Setting units

- Enter settings menu (see 14. Settings menu)
- Press OK to select UNITS.
- Use buttons \blacktriangleleft \blacktriangleright to choose between acceleration (A), velocity (V), displacement (D).
- Use buttons \triangle ∇ to select units.
- Press OK to save and return to settings menu.



17. Setting low pass filter

- Enter settings menu (see 14. Settings menu)
- Press  to select FILTER.
- Use buttons   to choose between 1, 5, 10 kHz.
- Press  to save and return to settings menu.

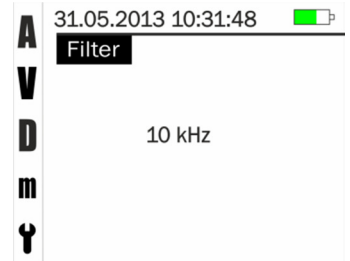
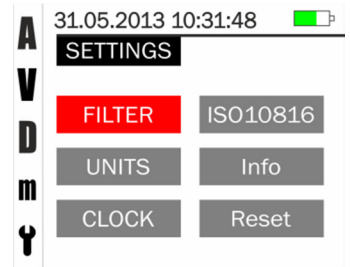



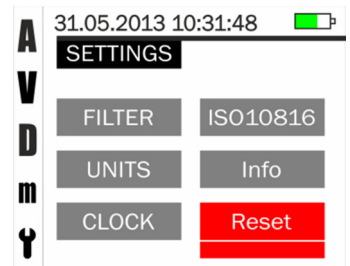

18. Clearing memories

- Enter settings menu (see 14. Settings menu)
- Press  to select RESET.
- A red bar will appear under the button to indicate progress.

NOTE: The clock and unit settings will be unaffected.



19. Setting ISO10816 group

- Enter settings menu (see 14. Settings menu)
- Press  to select ISO10816 (see 20. ISO10816).
- Use buttons   to select group (1F, 1R, 2F, 2R, 1<, 1>, 2<, 2>).
- Press  to save and return to settings menu.

1F	ISO10816-3 Group 1 (300kW-50MW) flexible foundation
1R	ISO10816-3 Group 1 (300kW-50MW) rigid foundation
2F	ISO10816-3 Group 1 (15kW-300kW) flexible foundation
2R	ISO10816-3 Group 1 (15kW-300kW) rigid foundation
1<	ISO10816-7 Category 1 (<200kW)
1>	ISO10816-7 Category 1 (>200kW)
2<	ISO10816-7 Category 2 (<200kW)
2>	ISO10816-7 Category 2 (>200kW)

See 20. ISO10816

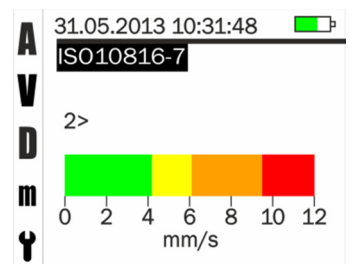
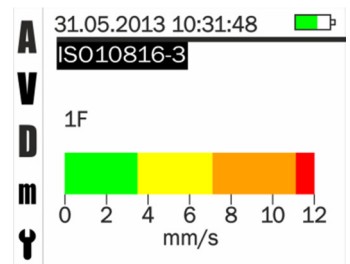
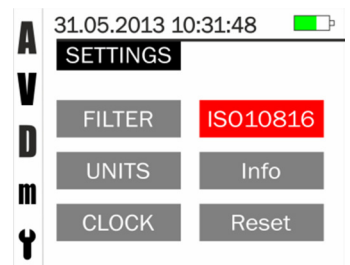

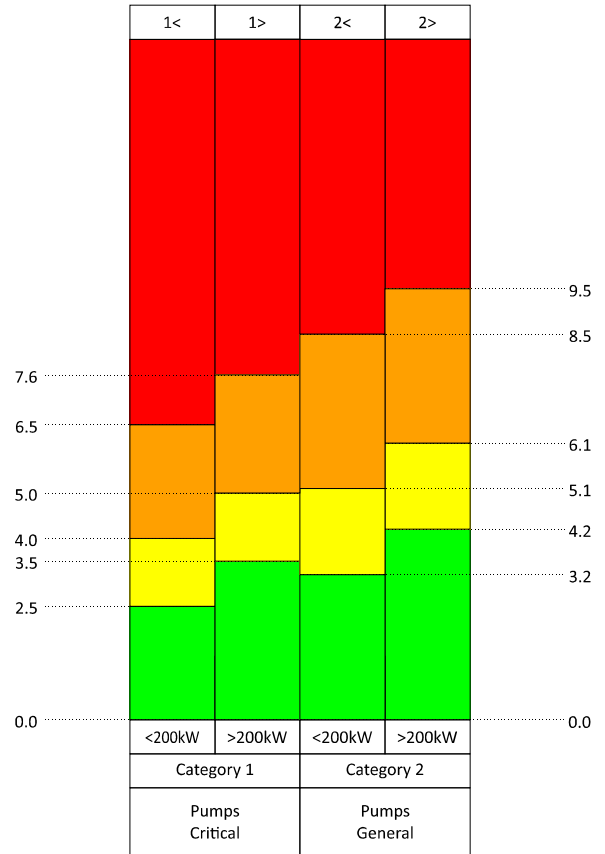
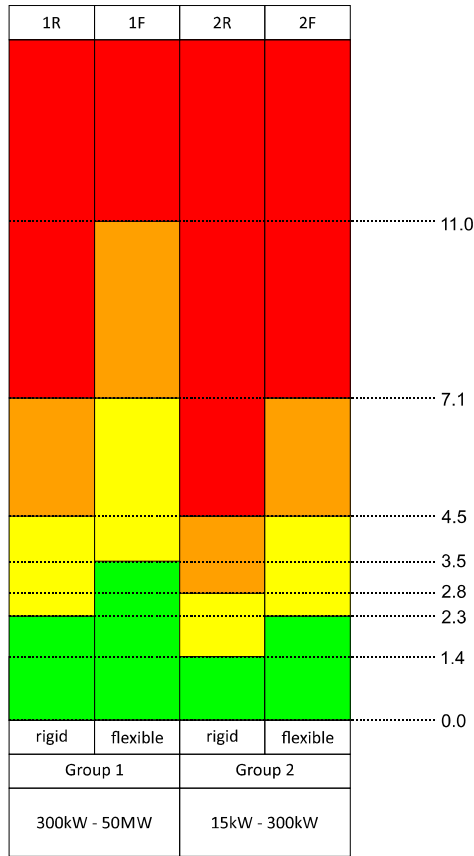

ISO10816-3:2009

Industrial machines with nominal power above 15kW and nominal speeds between 120rpm and 15000rpm when measured in situ.

ISO10816-7:2009

Rotodynamic pumps for industrial applications, including measurements on rotating shafts.

1F	ISO10816-3 Group 1 (300kW-50MW) flexible foundation
1R	ISO10816-3 Group 1 (300kW-50MW) rigid foundation
2F	ISO10816-3 Group 2 (15kW-300kW) flexible foundation
2R	ISO10816-3 Group 2 (15kW-300kW) rigid foundation

1<	ISO10816-7 Category 1 (<200kW)
1>	ISO10816-7 Category 1 (>200kW)
2<	ISO10816-7 Category 2 (<200kW)
2>	ISO10816-7 Category 2 (>200kW)

	Sufficient severity to cause damage to the machine
	Restricted operation until remedial action can be taken
	Unrestricted long-term operation
	Newly commissioned machines

Please consult ISO10816 standards for more information.

All dimensions in mm, unless stated otherwise.

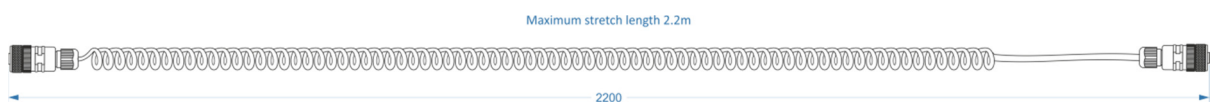
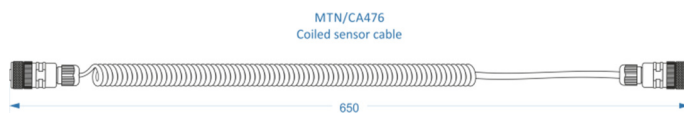
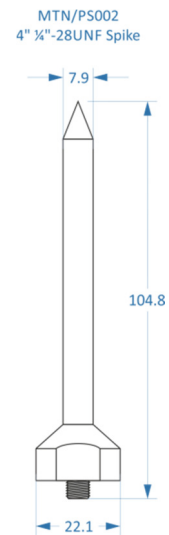
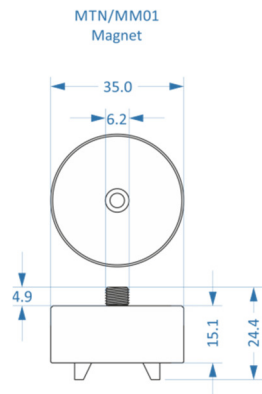
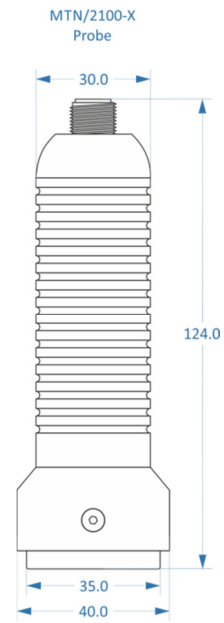
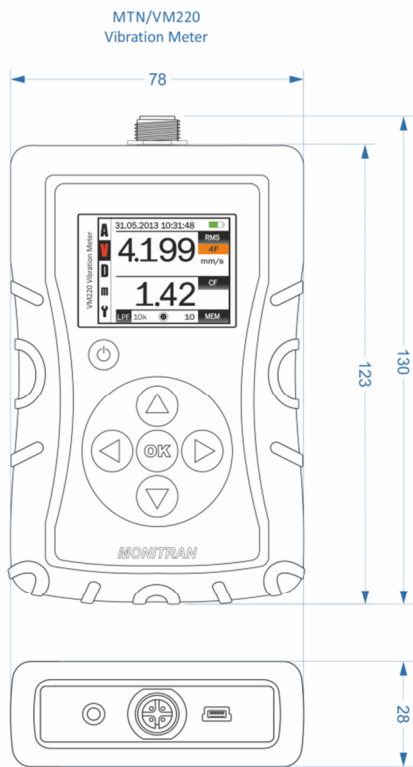

22. Specifications

Measurement ranges





Acceleration	20g
Velocity	200mm/s
Displacement	2000 μ m

Different ranges available

Modes	RMS Peak Peak-peak Crest factor Bearing acceleration Bearing velocity
-------	--

ISO10816

- ISO10816-3: 4 modes
ISO10816-3 Group 1 (300kW-50MW) flexible foundation
ISO10816-3 Group 1 (300kW-50MW) rigid foundation
ISO10816-3 Group 1 (15kW-300kW) flexible foundation
ISO10816-3 Group 1 (15kW-300kW) rigid foundation
- ISO10816-7: 4 modes
ISO10816-7 Category 1 (<200kW)
ISO10816-7 Category 1 (>200kW)
ISO10816-7 Category 2 (<200kW)
ISO10816-7 Category 2 (>200kW)
- Visual indication of machine status:

	Severe
	Restricted
	Unrestricted
	Good

Frequency range

Low pass filters	1kHz, 5kHz, 10kHz
Band-pass filter	1-10kHz

Units

Acceleration	g, m/sec ²
Velocity	mm/sec, in/sec
Displacement	μ m, mils

Display

Type	TFT 16bit colour
Resolution	160 x 128
Viewing angle	100°
Viewable size	35 x 28mm

Memory

Size	100 slots storing vibration, time, date, filter, units, crest factor
------	--

Connections

Power	USB mini-B
Headphones/AC signal	3.5mm stereo
Sensor	4 pin Lumberg

Environmental	
Operating temperature	0 to +45°C
Storage temperature	-20 to +60°C
Protection:	IP54
Power	
Charger	100-240V/5V 1A USB with 4 adaptors
Battery	Li-ion 3.7V
Battery life	>20 hours
Power status	Battery icon indicates charging status, battery level
Dimensions	
Size (L x W x H)	130 x 78 x 28mm
Weight (meter only)	0.215kg
(complete kit)	1.427kg
Accessories	
MTN/VM220	Vibration meter
MTN/2100-X	Probe
MTN/MM001	Magnet
MTN/PS002	4" ¼"-28UNF Spike
MTN/CA476	Coiled sensor cable
MTN/CA477	USB A to mini USB B cable
MTN/BT004	Worldwide adaptor with 4 adaptors
MTN/HE016	Carry case
MTN/HB039	Handbook

23. Troubleshooting

The unit will not power on	<ul style="list-style-type: none">• Recharge battery.
The battery will not charge	<ul style="list-style-type: none">• Try a different charger.• Check charger cable for signs of damage.• Return the unit to Monitran for service.
The unit has frozen	<ul style="list-style-type: none">• Hold the  button for at least 10 seconds to force the unit to perform a hard shutdown. Wait a few seconds, then restart as usual.
The unit is displaying unexpected readings	<ul style="list-style-type: none">• Ensure connectors are securely fastened at both ends of the cable.• Check cable and connectors for signs of damage.

24. After Sales Support

Warranty

All products are guaranteed against defects in materials and workmanship for a period of 24 months from the date of purchase. In the event of failure within 24 months of the original purchase the Company will promptly repair or replace any defective products without charge.

This warranty is void if repair has been attempted by unauthorised persons or agents, if the products have been used for purposes for which they were not intended, if they have been subjected to abuse or wilful neglect or if the user has in any way failed to take sufficient precautions to safeguard the products.

No liability will be accepted for loss of items or component parts.

Recalibration

It is recommended that the Vibration Meter is recalibrated annually to maintain optimum performance.

Monitran are pleased to provide this service. Please contact our Sales Office for details.

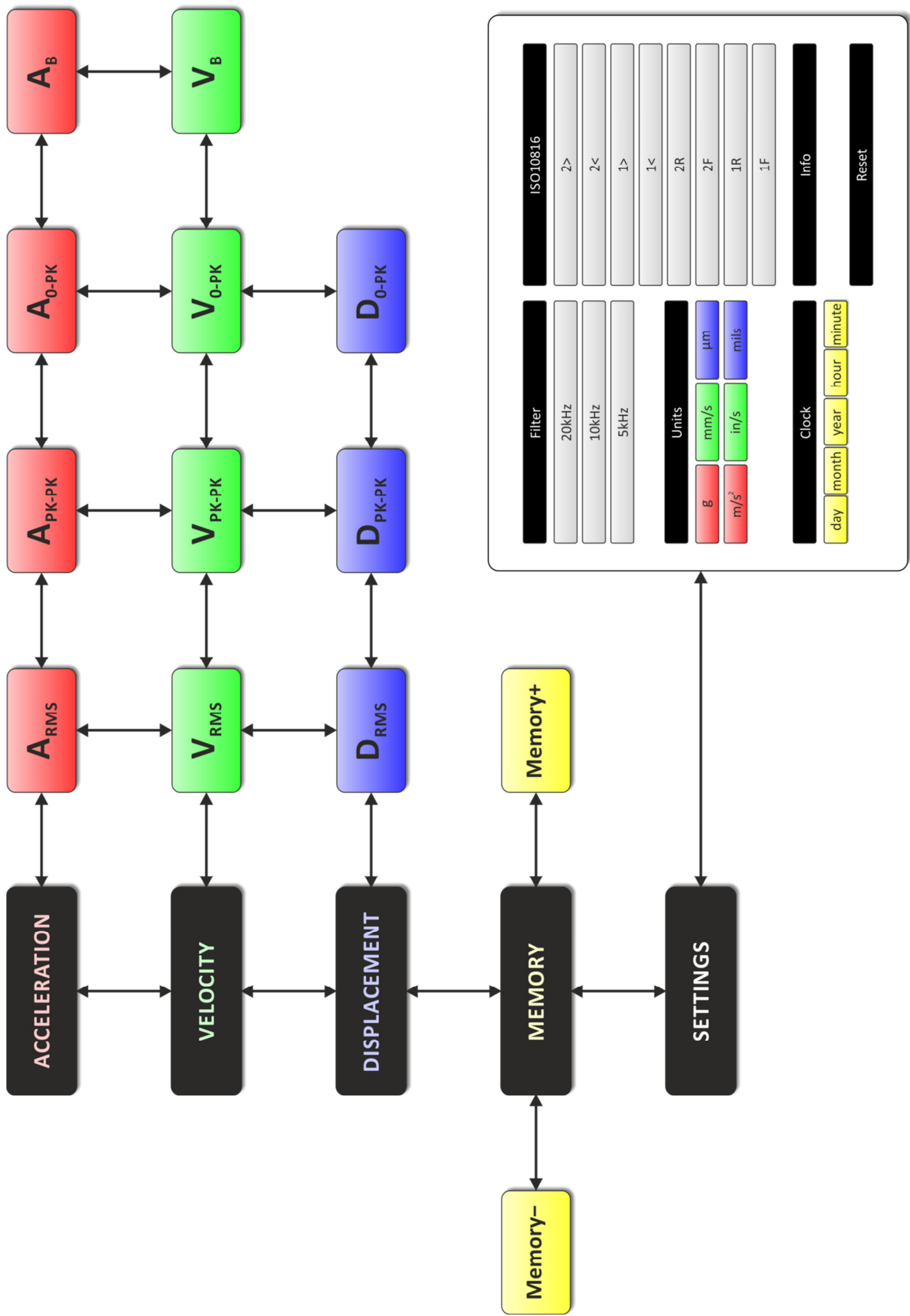

ACCELERATION			
m/s ²	g	in/s ²	ft/s ²
1	0.102	39.37	3.281
9.807	1	386.1	32.17
0.0254	0.00259	1	0.08333
0.3048	0.03108	12	1

$$A = V \cdot 2\pi F = D \cdot (2\pi F)^2$$

A V D F
m/s² m/s m Hz

$$A = \frac{V \cdot 2\pi F}{1000} = \frac{D \cdot (2\pi F)^2}{1000000}$$

m/s² mm/s μm Hz

$$A = \frac{V \cdot 2\pi F}{9807} = \frac{D \cdot (2\pi F)^2}{9806650}$$

g mm/s μm Hz

VELOCITY			
mm/s	m/s	in/s	ft/s
1	0.001	0.03937	0.003281
1000	1	39.37	3.281
25.4	0.0254	1	0.08333
304.8	0.3048	12	1

$$V = \frac{A}{2\pi F} = D \cdot 2\pi F$$

m/s² m/s m Hz

$$V = \frac{1000 \cdot A}{2\pi F} = D \cdot \frac{2\pi F}{1000}$$

m/s² mm/s μm Hz

$$V = \frac{9810 \cdot A}{2\pi F} = D \cdot \frac{2\pi F}{1000}$$

g mm/s μm Hz

DISPLACEMENT			
μm	mm	mils	in
1	0.001	0.03937	0.0000394
1000	1	39.37	0.03937
0.0254	0.0000254	1	0.001
25400	25.4	1000	1

$$D = \frac{A}{(2\pi F)^2} = \frac{V}{2\pi F}$$

m/s² m/s m Hz

$$D = \frac{1000000 \cdot A}{(2\pi F)^2} = \frac{1000 \cdot V}{2\pi F}$$

m/s² mm/s μm Hz

$$D = \frac{9806650 \cdot A}{(2\pi F)^2} = \frac{1000 \cdot V}{2\pi F}$$

g mm/s μm Hz

FREQUENCY			
Hz	CPS	RPM	CPM
1	1	60	60
1	1	60	60
0.01667	0.01667	1	1
0.01667	0.01667	1	1

Where: A = Acceleration
V = Velocity
D = Displacement
F = Frequency

Waveform	RMS value	Crest factor
Sine wave	$\frac{1}{\sqrt{2}} \approx 0.707$	$\sqrt{2} \approx 1.414$
Triangle wave	$\frac{1}{\sqrt{3}} \approx 0.577$	$\sqrt{3} \approx 1.732$
Sawtooth wave	$\frac{1}{\sqrt{3}} \approx 0.577$	$\sqrt{3} \approx 1.732$
Square wave	1	1

Where: Peak-peak = 1

